

AGOSTO 2025

SUELOS DE EXTERIOR LOSETAS COMPOSITE

Las losetas de composite ofrecen una serie de ventajas a la hora de hacer instalaciones de terrazas y jardines, entre las que destacan:

Durabilidad: Las baldosas de composite son muy resistentes a la intemperie, a los rayos UV y a los insectos. Esto las hace una opción ideal para zonas expuestas a condiciones climáticas adversas.

Bajo mantenimiento: Las baldosas de composite no requieren un mantenimiento regular. No es necesario barnizarlas ni teñirlas, lo que ahorra tiempo y dinero.

Aspecto natural: Las baldosas de composite están disponibles en una amplia gama de colores y acabados que imitan a la madera natural. Esto las convierte en una opción estéticamente atractiva.

Facilidad de instalación: Las baldosas de composite se instalan de forma rápida y sencilla, sin necesidad de obras. Esto las hace una opción ideal para proyectos de bricolaje.

En concreto, las ventajas de las baldosas de composite para terrazas y jardines son las siguientes:

Resistencia al agua: Las baldosas de composite son resistentes a la humedad, por lo que no se deforman ni se hinchan con el agua. Esto las hace ideales para zonas cercanas a piscinas o fuentes.

Antideslizante: La superficie de las baldosas de composite es antideslizante, lo que las hace seguras para caminar sobre ellas, incluso cuando están mojadas.

Resistente a las manchas: Las baldosas de composite son resistentes a las manchas, por lo que son fáciles de limpiar.

Variabilidad de diseños: Las baldosas de composite están disponibles en una amplia gama de diseños, desde diseños tradicionales hasta diseños modernos.

Por todas estas razones, las losetas de composite son una opción muy popular para la construcción de terrazas y jardines.



 **PanBLOCK30**
LOSETAS DE 30 X 30

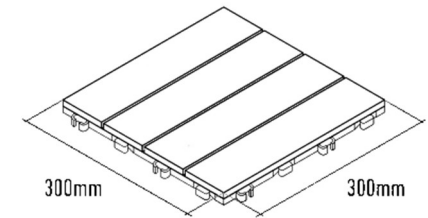

Colores

- Gris Antracita.
- Chocolate.
- Teka.

Acabado:

- Superficie: ranurada antideslizante.

Medidas:

Medidas de la loseta:

- 300 x 300 x 25 mm.

Embalaje:

Unidades por caja:

- 11 unidades.

Unidades por m²:

- 11,11 uds.

Cajas por palé:

- 36 cajas.

Lamas por m²:

- 2,86 unidades.

m² por palé:

- 35,64 m².

Peso por caja:

- 14,90 Kg.

Peso por palé:

- 535,3 Kg.

PanBLOCK30



NON SLIP



EASY
MAINTENANCE



100%
RECYCLABLE



ANTIALERGIC
ANTIBACTERIAL

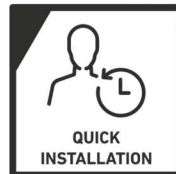

QUICK
INSTALLATION





 **PanBLOCK30**
Ref. CHOCOLATE





 **PanBLOCK30**
Ref. GRIS ANTRACITA

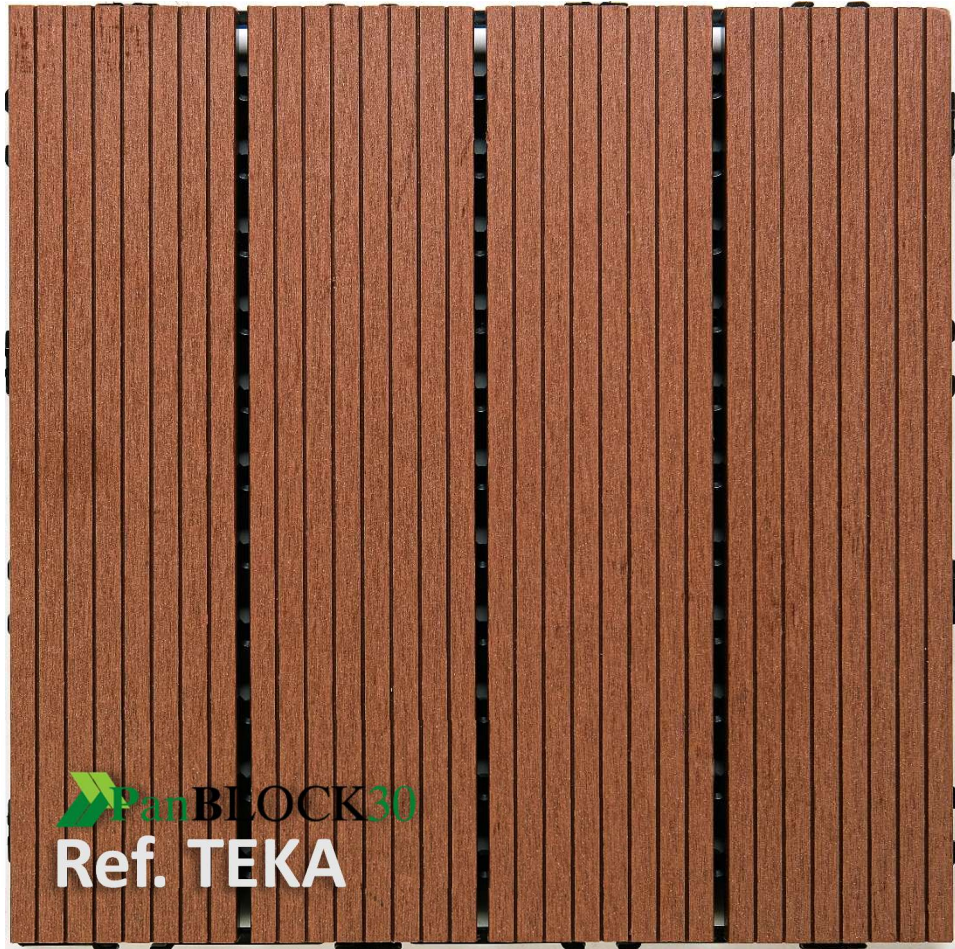

 PanBLOCK30
Ref. TEKA

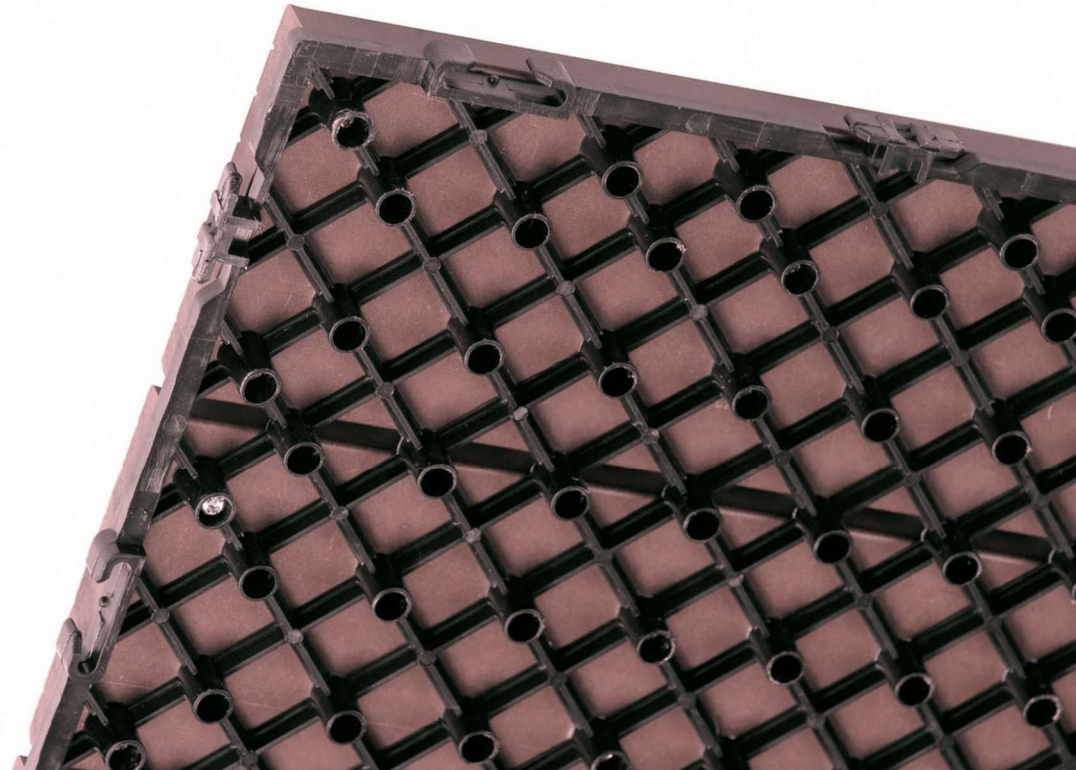



 **PanBLOCK50**
LOSETAS DE 50 X 50

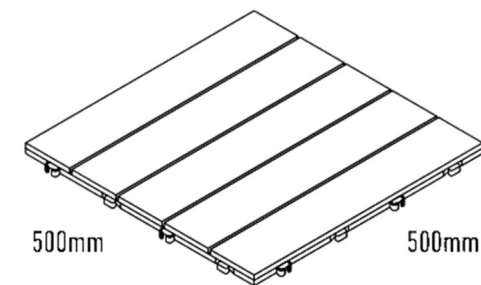

Colores

- Chocolate.

Acabado:

- Superficie: ranurada antideslizante.

Medidas:

Medidas de la loseta:

- 500 x 500 x 25 mm.

Embalaje:

Unidades por caja:

- 5 unidades.

Unidades por m²:

- 4 unidades.

Cajas por palé:

- 28 cajas.

Unidades por palé:

- 140 unidades

m² por caja:

- 1,25 m².

m² por palé:

- 35,00 m².

Peso por caja:

- 19,60 Kg.

Peso por palé:

- 548,90 Kg.

PanBLOCK50



NON SLIP



EASY
MAINTENANCE



100%
RECYCLABLE



ANTIALLERGIC
ANTIBACTERIAL



QUICK
INSTALLATION



FSC
www.fsc.org
FSC® C134296

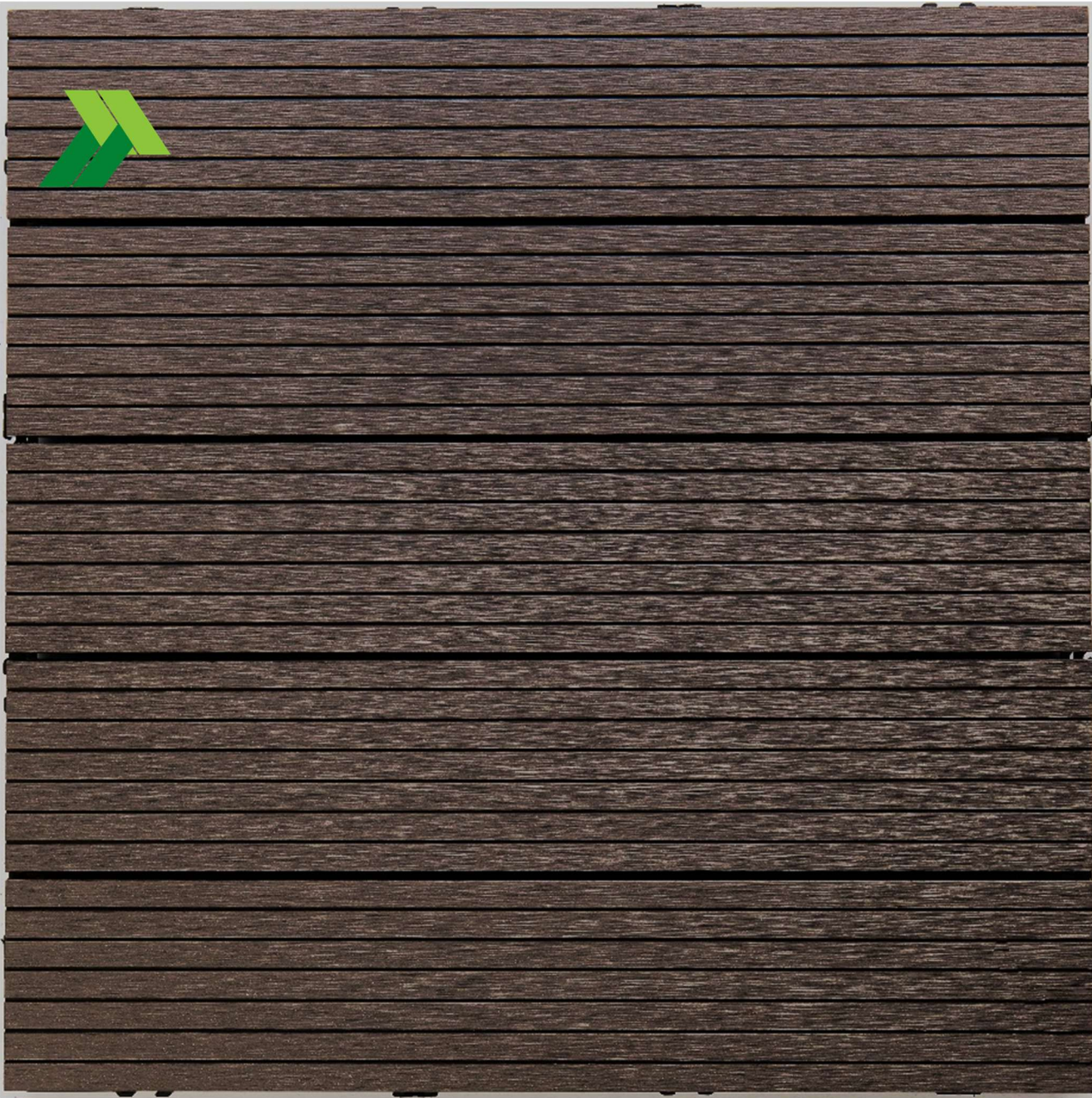

 **PanBLOCK50**
Ref. CHOCOLATE



 **PanBLOCK 5N**
LOSETAS DE 50 X 50

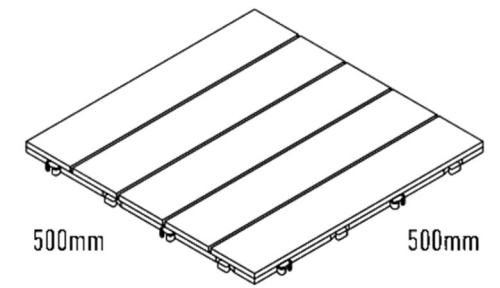

Colores

- Teka.
- Gris.

Acabado:

- Superficie: texturada.

Medidas:

Medidas de la loseta:

- 500 x 500 x 25 mm.

Embalaje:

Unidades por caja:

- 4 unidades.

Unidades por m²:

- 4 unidades.

Cajas por palé:

- 36 cajas.

Unidades por palé:

- 144 unidades.

m² por caja:

- 1,00 m².

m² por palé:

- 36,00 m².

Peso por caja:

- 19,60 Kg.

Peso por palé:

- 522,90 Kg.

PanBLOCK5N

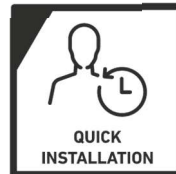



 PanBLOCK5N
Ref. Teka

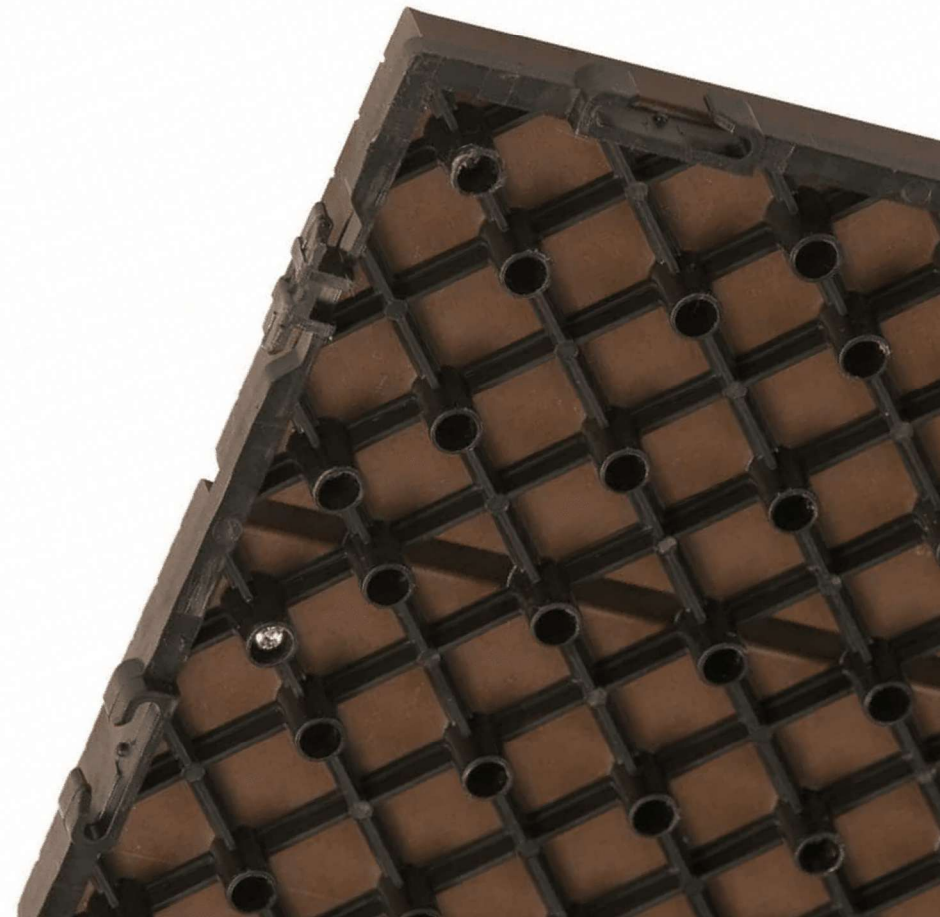

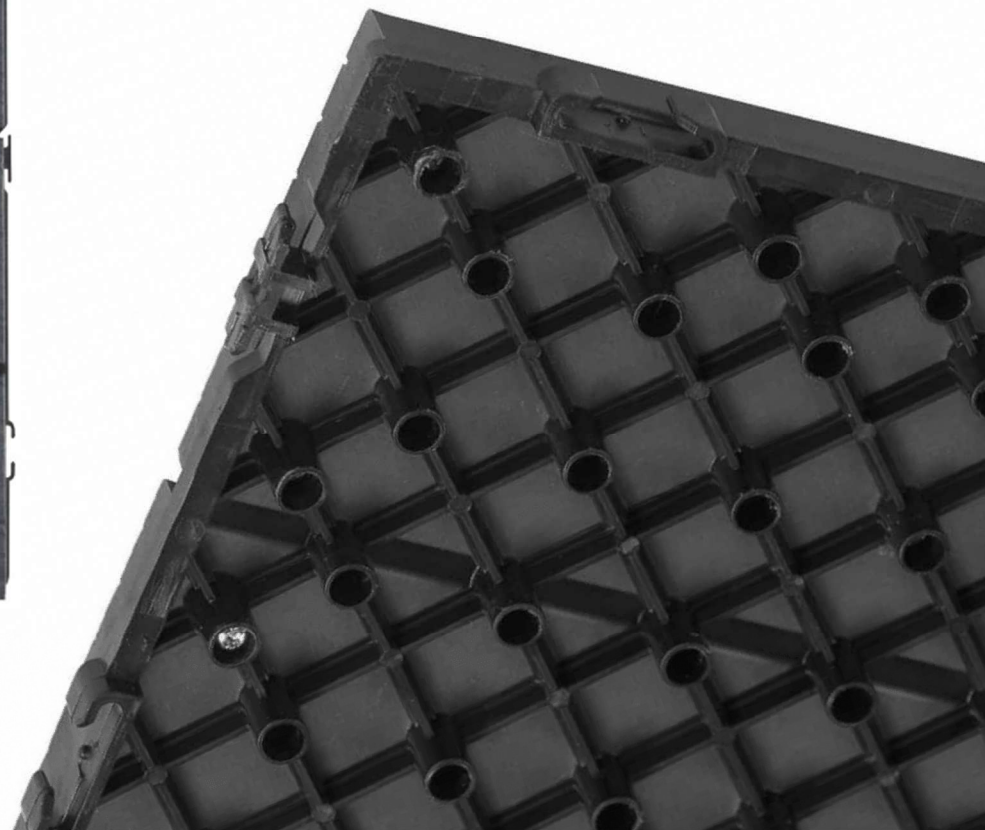

 PanBLOCK5N
Ref. Gris



 **PanBLOCK90**
LOSETAS DE 90 X 90 RASTRELADAS

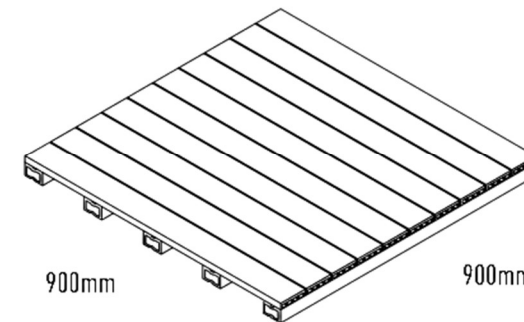
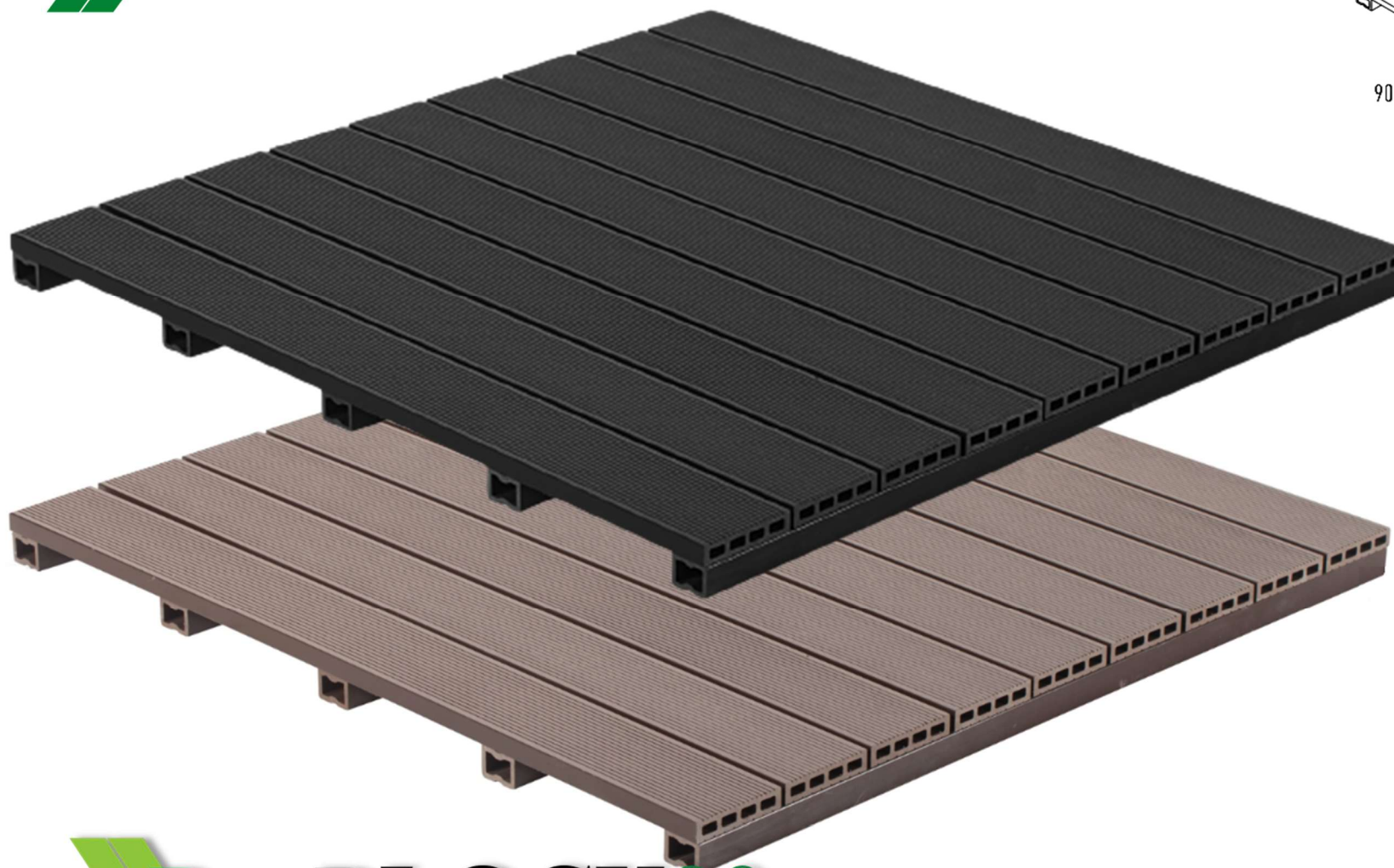

Colores

- Gris antracita.
- Chocolate.

Acabado:

- Superficie: ranurada. antideslizante.

Medidas:

Medidas de la loseta:

- 900 x 900 x 50 mm.

Embalaje:

Unidades por m²:

- 1,23 unidades.

Unidades por palé:

- 28 unidades.

m² por palé:

- 22,68 m².

Peso por unidad:

- 16,10 Kg.

Peso por palé:

- 451,20 Kg.

PanBLOCK 90





 **PanBLOCK90**
Ref. Chocolate

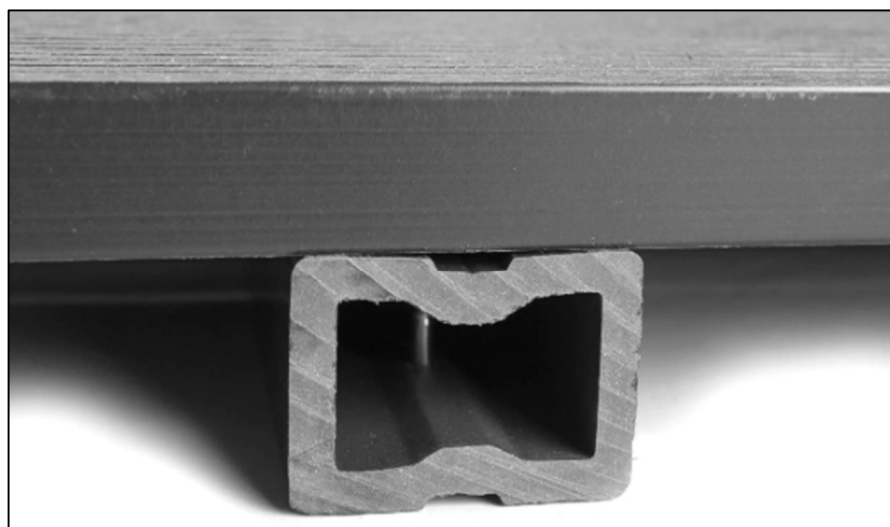

 **PanBLOCK90**
Ref. Gris antracita

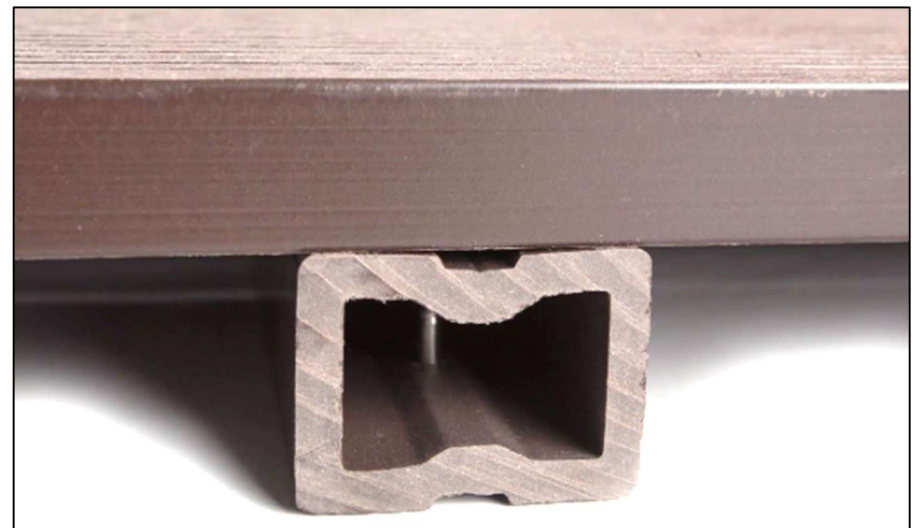

 **PanBLOCK90**
Ref. Ipe



 **PanBLOCK9N**

LOSETAS ENCAPSULADAS DE 90 X 90 RASTRELADAS

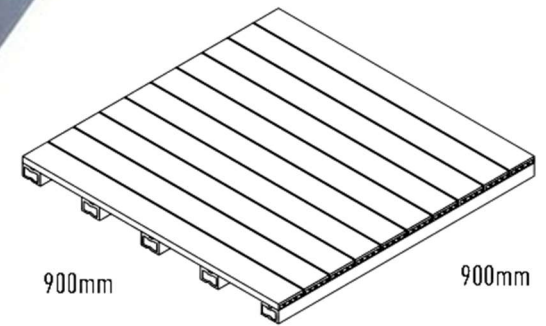

Colores

- Teka

Acabado:

- Superficie: encapsulada, texturada y antideslizante.

Medidas:

Medidas de la loseta:

- 900 x 900 x 50 mm.

Embalaje:

Unidades por m²:

- 1,23 unidades.

Unidades por palé:

- 28 unidades.

m² por palé:

- 22,68 m².

Peso por unidad:

- 16,10 Kg.

Peso por palé:

- 451,20 Kg.

PanBLOCK9N





 PanBLOCK9N
Ref. Teka

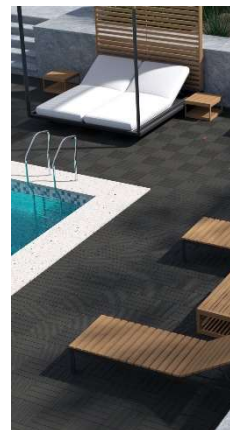
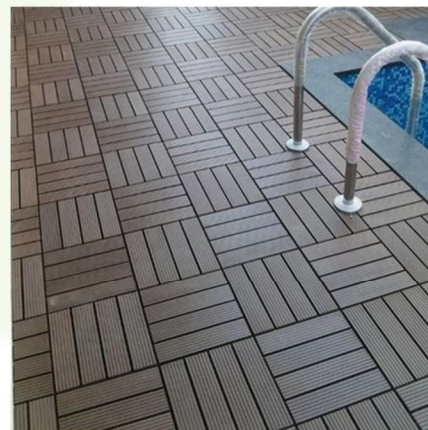
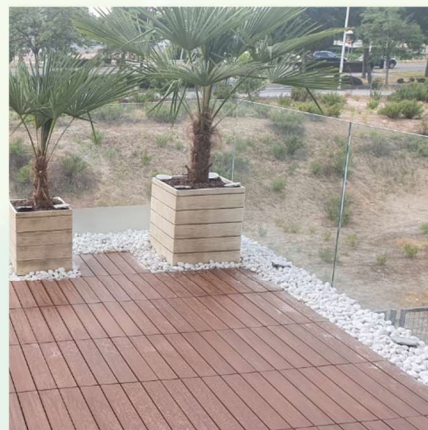
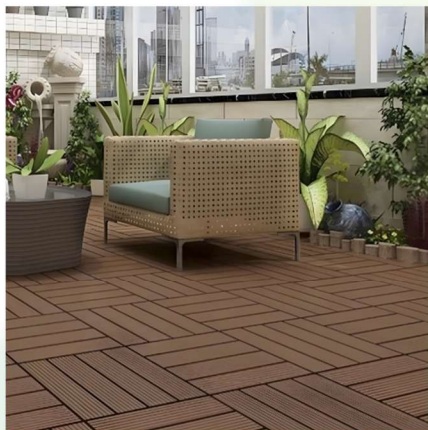



SUELOS Y TARIMAS PANDIRO S.L.
CIF. B-55635858
Delegaciones en Tarragona y Málaga

Telf. 677 08 91 97
www.pandiro.es
Info@pandiro.es